

Sc

KEY STAGE  
3TIER  
3-6

2005

# Science test

## Paper 2

Please read this page, but do not open the booklet until your teacher tells you to start. Write your name and the name of your school in the spaces below.

**First name** \_\_\_\_\_

**Last name** \_\_\_\_\_

**School** \_\_\_\_\_

### Remember

- The test is 1 hour long.
- You will need: pen, pencil, rubber, ruler, protractor and calculator.
- The test starts with easier questions.
- Try to answer all of the questions.
- The number of marks available for each question is given below the mark boxes in the margin. You should not write in this margin.
- If you are asked to plan an investigation, there will be space for you to write down your thoughts and ideas.
- Do not use any rough paper.
- Check your work carefully.
- Ask your teacher if you are not sure what to do.

For marker's  
use only

Total marks	
Borderline check	

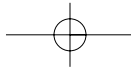

1. (a) Alfie made a model of part of the solar system.  
He used metal balls for the Sun, the Moon and the planets.

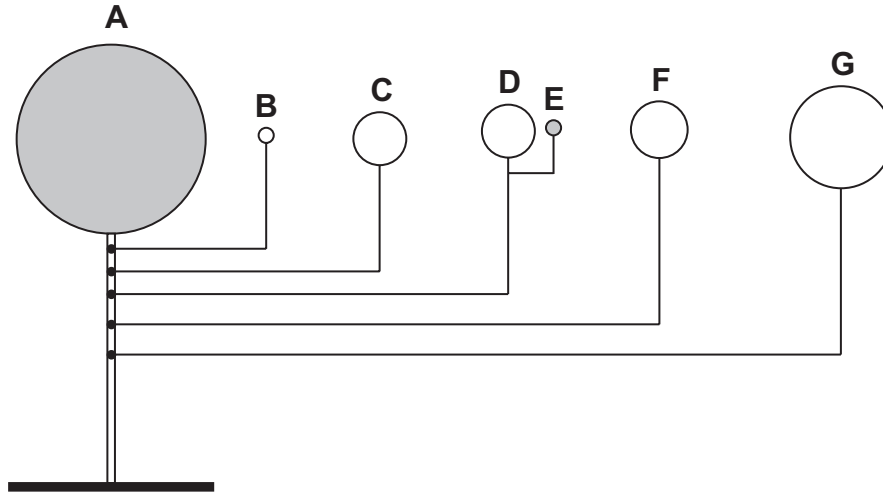

- E goes around D.
- B, C, D, F and G go around A.

Give the letter that is used to label:

- (i) the model Sun;

1ai  
1 mark

\_\_\_\_\_

- (ii) the model Earth;

1aii  
1 mark

\_\_\_\_\_

- (iii) the model Moon;

1aiii  
1 mark

\_\_\_\_\_

- (iv) the model planet with the largest orbit.

1aiv  
1 mark

\_\_\_\_\_

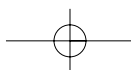

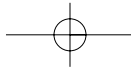

(b) The bar chart shows the force of gravity on eight of the planets.

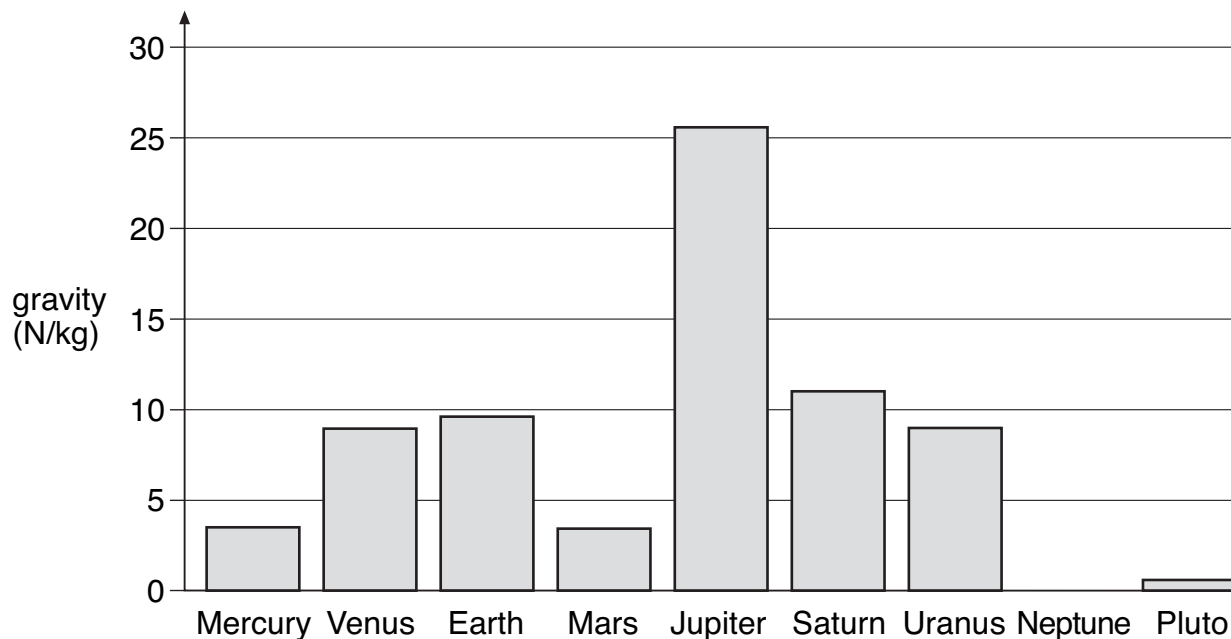

(i) The gravity on Neptune is 12 N/kg.

On the chart above, draw a bar for the planet Neptune.  
Use a ruler.

(ii) Give the name of a planet where you would weigh more than you weigh on Earth.

\_\_\_\_\_

(iii) On which planet would a spaceship need the largest force to take off?

\_\_\_\_\_

1bi  
1 mark

1bii  
1 mark

1biii  
1 mark

*maximum 7 marks*

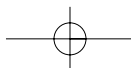

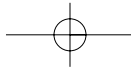

2. The drawing shows a snow-buggy being pulled by a sail.  
The buggy rests on three skis on the snow.

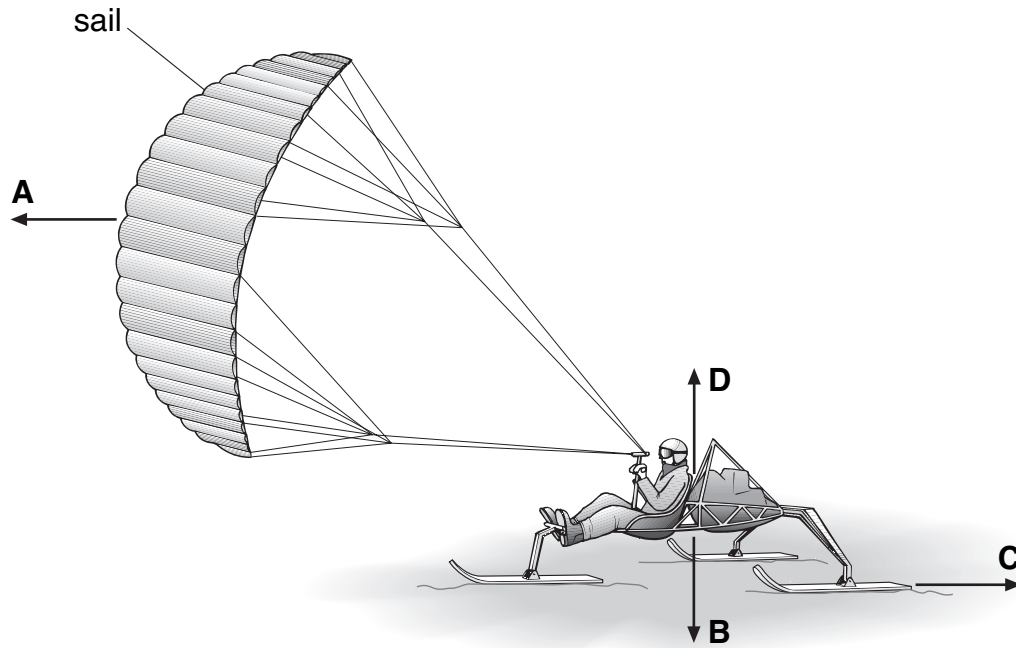

- (a) The drawing shows four forces that act when the snow-buggy is moving.

Draw a line from each force in the list below to the correct letter from the diagram.

Draw only **three** lines.

**force**

**letter**

the weight of the buggy

A

the force pulling the buggy along

B

the friction between the skis and the snow

C

D

2a  
1 mark

2a  
1 mark

2a  
1 mark

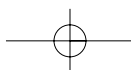

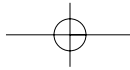

(b) A scientist travelled 80 kilometres (km) each day in the buggy.

How many kilometres did he travel in 10 days?

\_\_\_\_\_ km

2b  
1 mark

(c) The buggy carried the scientist, food and equipment for the journey. The table shows how the total mass changed.

	total mass at start of journey (kg)	total mass at end of journey (kg)
mass of buggy, scientist, food and equipment	295	130

The buggy sank deeper into the snow at the start of the journey than at the end.

Why did it sink deeper at the start? Use the table to help you.

\_\_\_\_\_

\_\_\_\_\_

2c  
1 mark

(d) The buggy rests on three skis instead of three wheels.

Why are skis better than wheels for travelling on snow?

\_\_\_\_\_

\_\_\_\_\_

2d  
1 mark

(e) When a bigger sail is used, the buggy goes faster.

How does a bigger sail help the buggy to go faster?

\_\_\_\_\_

\_\_\_\_\_

2e  
1 mark

*maximum 7 marks*

Total  
7

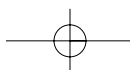

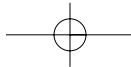

3. The thermometer drawn below can be used to measure the temperature of the human body.

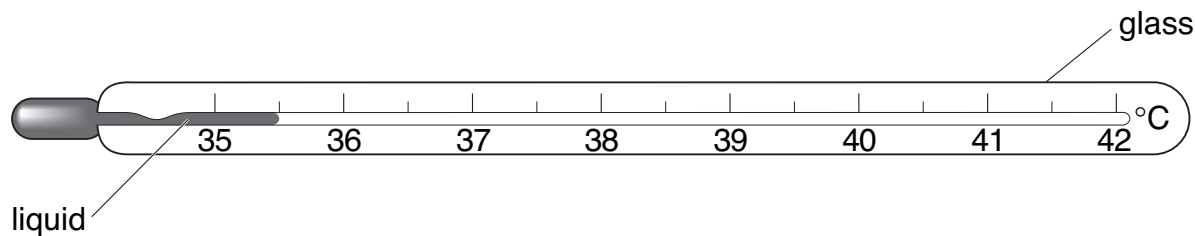

(a) (i) What is the lowest temperature **this** thermometer can measure?

3ai  
1 mark

\_\_\_\_\_ °C

(ii) What is the normal temperature of the human body?  
Tick the correct box.

3aii  
1 mark

37°C

39°C

41°C

(iii) When we are ill our temperature may go up.

A nurse can measure a child's temperature with two different thermometers as shown below.

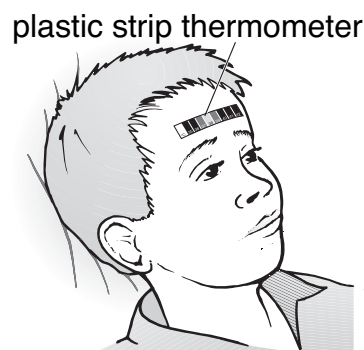
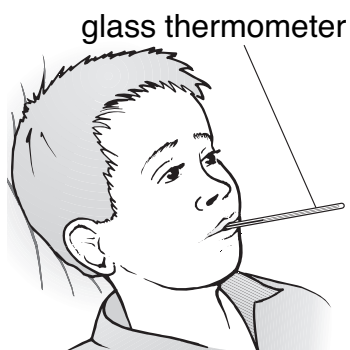

Give **one** reason why it is safer to use a plastic strip thermometer than a glass thermometer.

3aiii  
1 mark

---



---

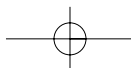

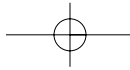

- (b) Viruses are micro-organisms that can make us ill.

Give the name of **one** other type of micro-organism that can make us ill.

\_\_\_\_\_

3b

1 mark

- (c) Alcohol and mercury are two liquids that can be used in glass thermometers. The table gives information about these liquids.

liquid	boiling point (°C)	colour
alcohol	78	colourless
mercury	357	shiny grey

- (i) A red dye is added to the colourless alcohol used in thermometers. Suggest a reason for this.

\_\_\_\_\_  
\_\_\_\_\_

3ci

1 mark

- (ii) Choose words from the list below to fill the gaps in the sentences.

**gas      liquid      solid**

When alcohol and mercury boil they both change from a liquid to  
a \_\_\_\_\_.

3cii

1 mark

A thermometer containing mercury can be used to measure the  
temperature of an oven at 150°C because mercury is a  
\_\_\_\_\_ at 150°C.

3cii

1 mark

*maximum 7 marks*

Total

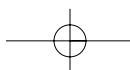

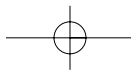

4. Table 1 below shows the colour of universal indicator in acidic, neutral and alkaline solutions.

	← acidic			neutral	alkaline →		
<b>colour of indicator</b>	red	orange	yellow	green	blue	dark blue	purple

**table 1**

Ramy tested different liquids with the indicator solution. His results are shown in table 2 below.

liquid	colour of indicator solution
milk	green
lemonade	orange
water	green
fruit juice	red
washing-up liquid	blue

**table 2**

- (a) Use Ramy's results to answer the following questions.

- (i) Give the name of **one** acidic liquid in **table 2**.

4ai  
1 mark

\_\_\_\_\_

- (ii) Give the name of **one** neutral liquid in **table 2**.

4aii  
1 mark

\_\_\_\_\_

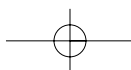

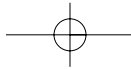

(b) Ramy dissolved some bicarbonate of soda in distilled water.  
This produced an alkaline solution.

(i) Ramy added the indicator to the alkaline solution.

Suggest what colour the indicator became.  
Use **table 1**, on the opposite page, to help you.

\_\_\_\_\_

4bi  
1 mark

(ii) Ramy added lemon juice to the solution of bicarbonate of soda.

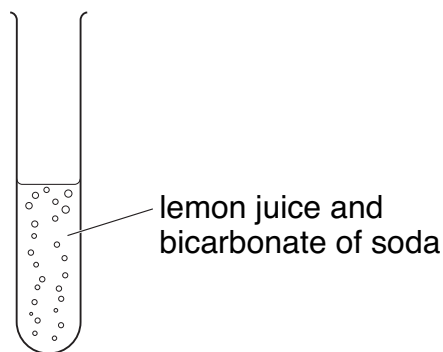

How could he tell that a gas was produced?

\_\_\_\_\_

4bii  
1 mark

(c) Ramy mixed an acid with an alkali and tested the mixture with the indicator solution.  
The indicator solution turned green.

What is the name of the reaction between an acid and an alkali?  
Tick the correct box.

condensation

crystallisation

evaporation

neutralisation

4c  
1 mark

*maximum 5 marks*

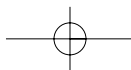

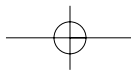

5. (a) Ruth added some blue copper sulphate crystals to a beaker of water.

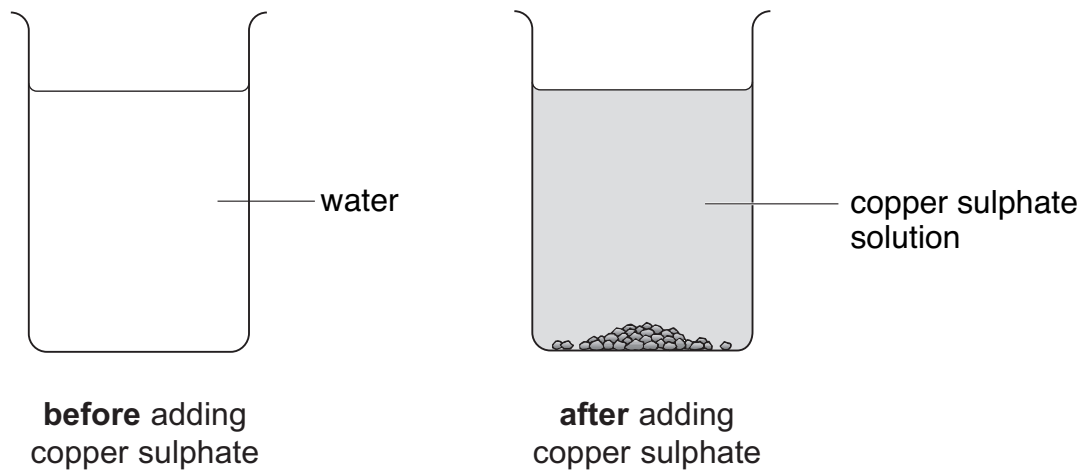

- (i) How could Ruth **see** that some of the copper sulphate crystals had dissolved in the water?

---

---

- (ii) How could Ruth make the copper sulphate crystals dissolve more quickly?

---

- (b) Ruth poured some of the copper sulphate solution into a dish. She left it in a warm room for five days.

All the water evaporated from the solution in the dish. What was left in the dish?

---

5ai  
1 mark

5aii  
1 mark

5b  
1 mark



- (c) Ruth did an experiment to see how much of three solids, P, Q and R, will dissolve in water at different temperatures. She plotted her results on graph paper as shown below.

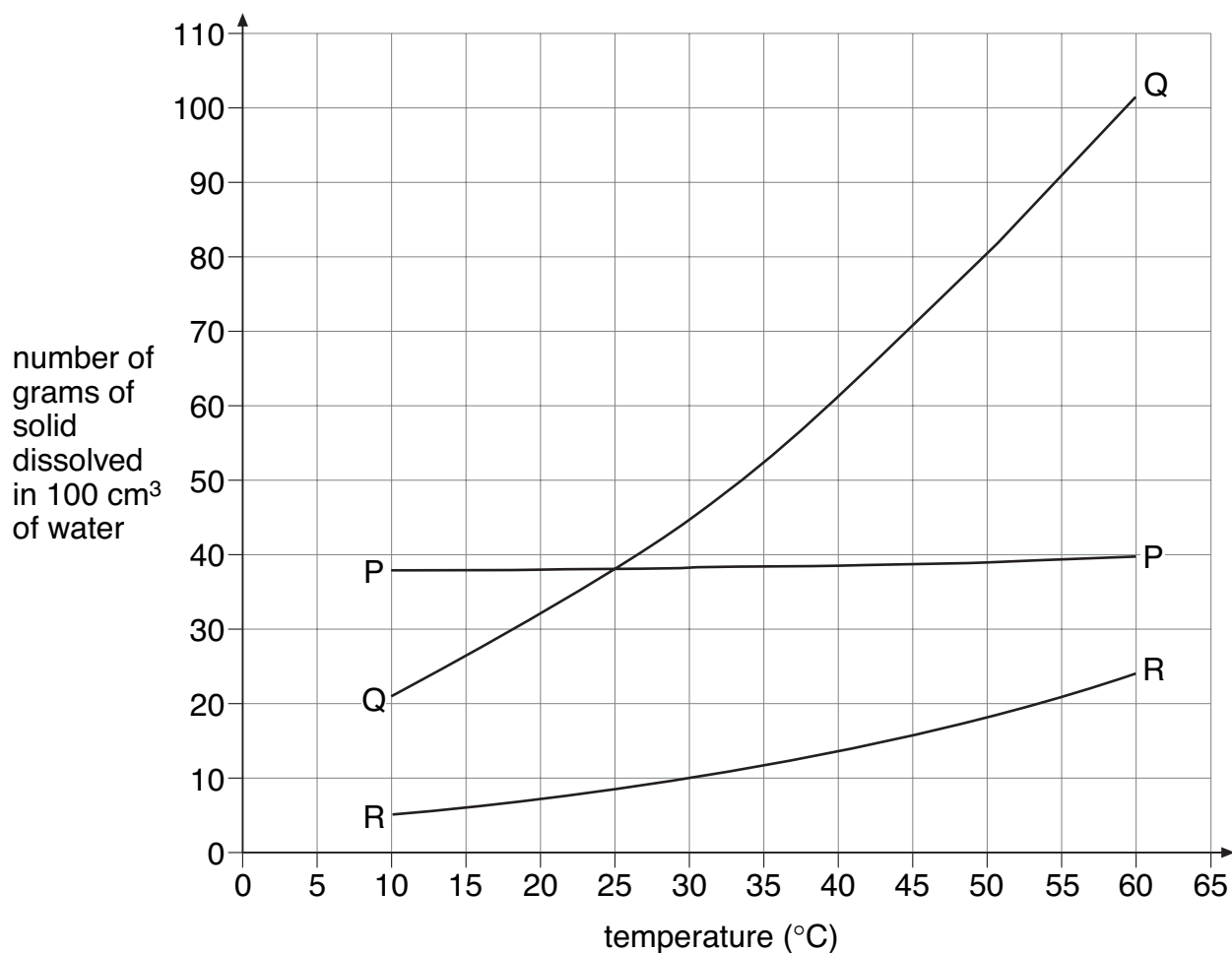

Use the graph above to answer the questions below.

- (i) At 30°C how many grams of solid R dissolved in the water?

\_\_\_\_\_ g

- (ii) At 60°C which solid dissolved the most in water? Give the letter.

\_\_\_\_\_

- (iii) Which **two** solids were equally soluble at 25°C? Give the letters.

\_\_\_\_\_ and \_\_\_\_\_

*maximum 6 marks*

5ci  
1 mark

5cii  
1 mark

5ciii  
1 mark

Total  
6

6. The diagram below shows the digestive system.

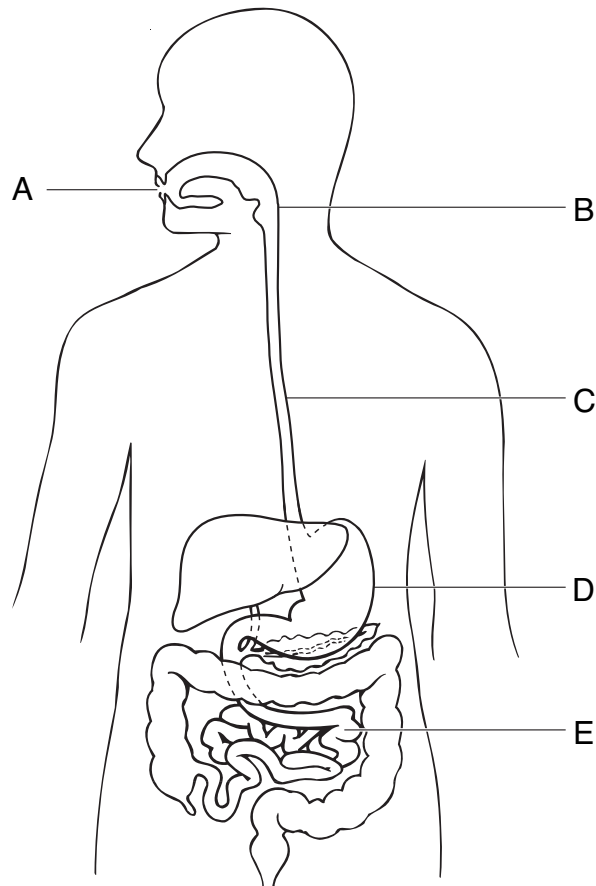

(a) (i) Give the letter which labels the stomach.

6ai  
1 mark

(ii) Give the letter which labels the small intestine.

6aii  
1 mark

(iii) Glucose is absorbed in the small intestine.

What carries glucose from the intestine to other parts of the body?

6aiii  
1 mark

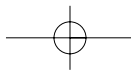

(b) Some athletes take glucose tablets before a race.

Why do they take glucose?  
Tick the correct box.

for growth	<input type="checkbox"/>	for healthy bones and teeth	<input type="checkbox"/>
to prevent disease	<input type="checkbox"/>	to provide energy	<input type="checkbox"/>

6b  
1 mark

(c) The table below shows what four people ate for lunch.

name	lunch
Jon	chicken and salad
Nadia	cheeseburger and chips
Clare	lemonade and a jam doughnut
Zak	mushroom soup and an orange

(i) Whose lunch had the most sugar in it?

\_\_\_\_\_

6ci  
1 mark

(ii) Whose lunch had the most fat in it?

\_\_\_\_\_

6cii  
1 mark

(iii) Eating too much fat is bad for you.  
Give **one** reason for this.

\_\_\_\_\_  
\_\_\_\_\_



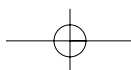

6ciii  
1 mark

*maximum 7 marks*

Total  
  
7

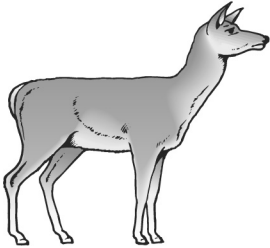

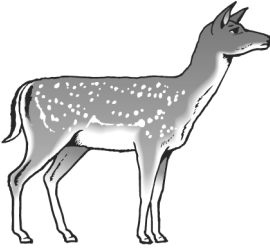
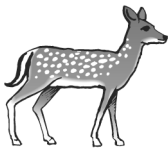
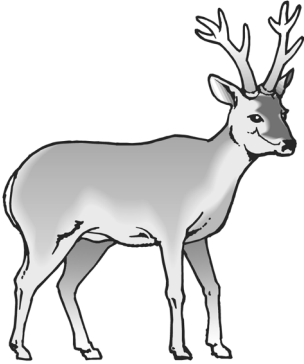
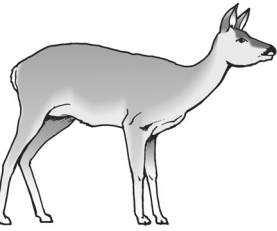
7. Some pupils visited a deer park.  
A poster showed different types of deer.

	adult male	adult female	young
Red deer			
Fallow deer			
Roe deer			

(a) Emily said, 'I saw a male deer'.

Look at the drawings in the poster.  
How would Emily know that the deer was male?

---



---

7a  
1 mark

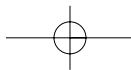

- (b) Jimmy made some notes about a young deer.

**Jimmy's notes**  
 skinny legs  
 small  
 spots on back

Give **one** reason why he **cannot** identify the type of young deer from his notes.

\_\_\_\_\_

 7b  
 1 mark

- (c) Dan drew one of the deer.

He said it was an adult male red deer.

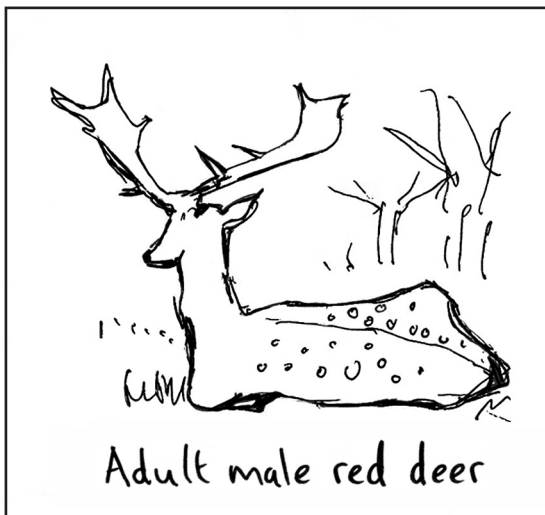

Give **two** pieces of evidence from his drawing which suggest that he got the name wrong.

1. \_\_\_\_\_
2. \_\_\_\_\_

 7c  
 1 mark

 7c  
 1 mark

- (d) Michael saw a deer like this.

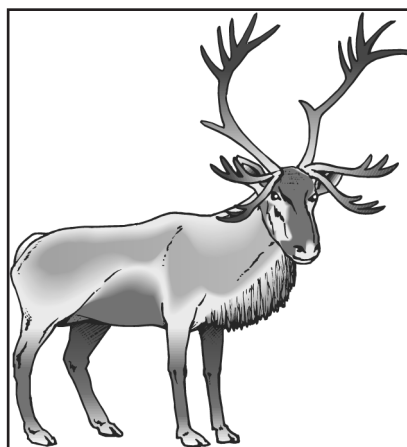

What **two** pieces of evidence show it was **not** one of the deer on the poster?

1. \_\_\_\_\_
2. \_\_\_\_\_

 7d  
 1 mark

 7d  
 1 mark

*maximum 6 marks*

Total  
  
 6

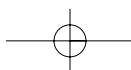

8. The drawing below shows a garden water feature. It is solar-powered.

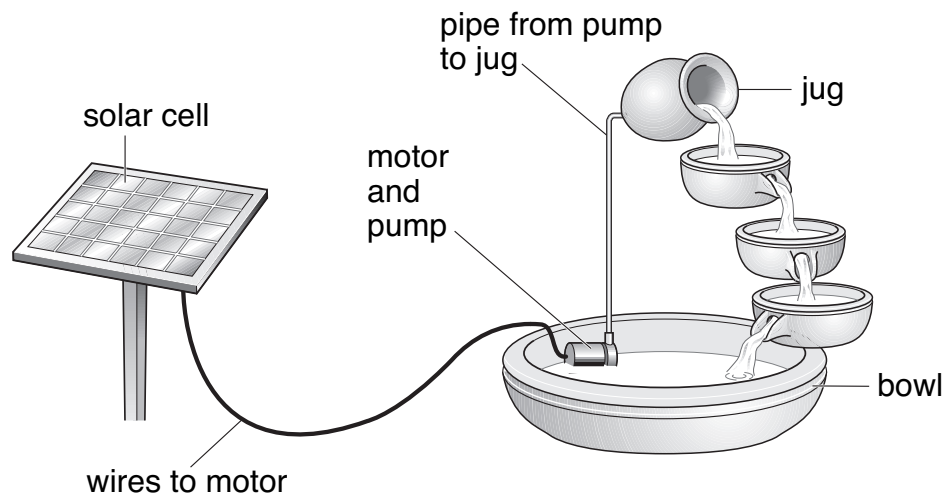

The solar cell absorbs energy from the Sun.  
 The solar cell is connected to a motor in the bowl.  
 The motor drives a pump.  
 Water is pumped up to the jug and it flows back down to the bowl.

(a) Use the information above to help you to complete the following sentences.  
 Choose words from the list.

- |          |            |                         |         |
|----------|------------|-------------------------|---------|
| chemical | electrical | gravitational potential | kinetic |
| light    | sound      | thermal                 |         |

(i) The useful energy change in the solar cell is from

light to \_\_\_\_\_ energy.

(ii) The useful energy change in the motor is from

electrical energy to \_\_\_\_\_ energy.

(iii) As the water flows from the jug to the bowl \_\_\_\_\_

energy is changed into \_\_\_\_\_ energy.

8ai

1 mark

8aii

1 mark

8aiii

1 mark

8aiii

1 mark

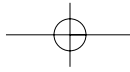

(b) Give **one** advantage and **one** disadvantage of using a solar cell to power the water feature.

advantage \_\_\_\_\_  
\_\_\_\_\_

disadvantage \_\_\_\_\_  
\_\_\_\_\_

8b  
1 mark

8b  
1 mark

*maximum 6 marks*

Total  
  
6



9. Lorna built the circuit drawn below. All the bulbs are identical.

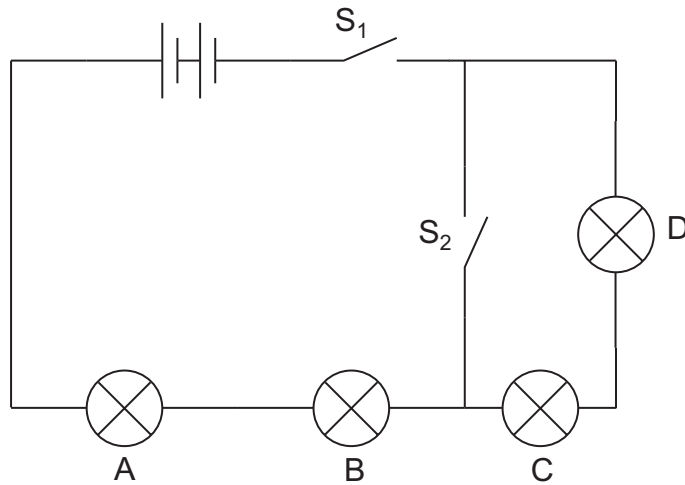

(a) Complete the table below by writing **on** or **off** for each bulb. One has been done for you.

switch		bulb			
S <sub>1</sub>	S <sub>2</sub>	A	B	C	D
open	open	off	off	off	off
open	closed				
closed	open				
closed	closed				

9a  
1 mark

9a  
1 mark

9a  
1 mark

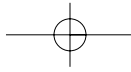

(b) Lorna then built a different circuit as shown below.

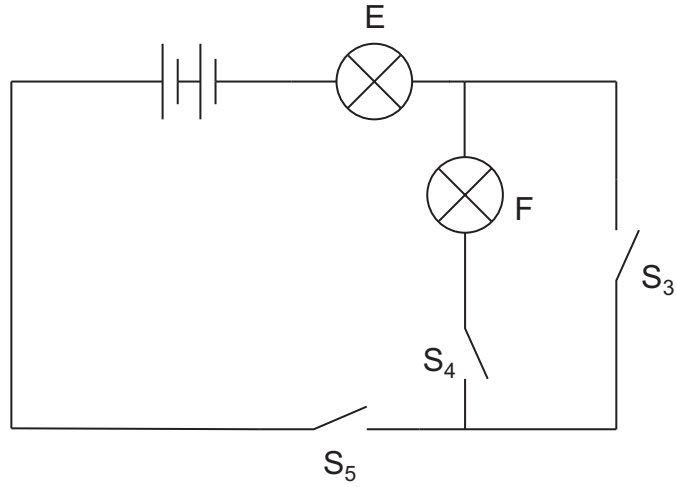

How could Lorna get both bulbs to light at the same time in this circuit?

---

---

9b

1 mark

*maximum 4 marks*

Total

4

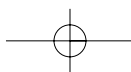

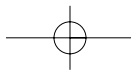

10. (a) (i) Air contains nitrogen.  
In the box below draw **five** circles, ○, to show the arrangement of particles in nitrogen gas.



10ai

1 mark

- (ii) Zeena carries a personal emergency alarm.  
It uses nitrogen gas to produce a very loud sound.

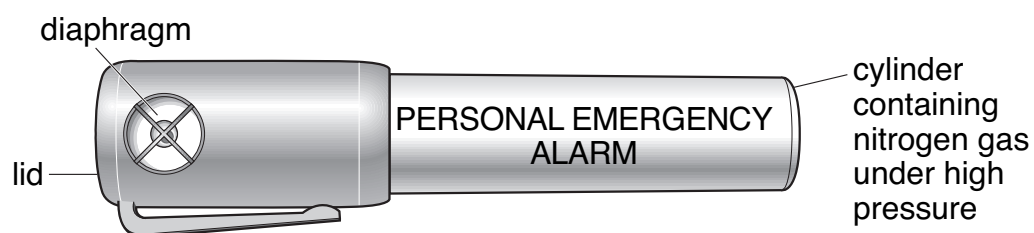

The nitrogen gas in the container is under much higher pressure than the nitrogen gas in the air.

How does the arrangement of nitrogen particles change when the gas is under higher pressure?

---



---



10aii

1 mark

- (b) Use words from the boxes below to complete the sentence.

**greater than**

**less than**

**the same as**

The rate at which the nitrogen particles hit the inside of the container is \_\_\_\_\_ the rate at which nitrogen particles hit the outside of the container.



10b

1 mark

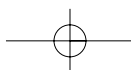

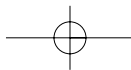

- (c) Zeena pushes the lid down and nitrogen gas escapes through the diaphragm.  
The diaphragm vibrates and produces a sound.

The pattern on the oscilloscope screen below represents the soundwave produced by the alarm.

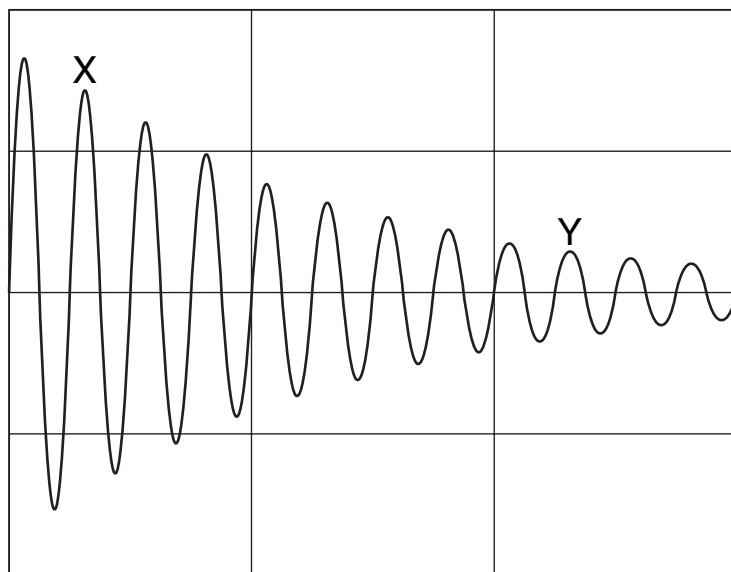

- (i) The loudness of the sound produced by the alarm decreases between X and Y.

How can you tell this from the graph?

---



---

10ci  
1 mark

- (ii) The pitch of the sound produced by the alarm stays the same between X and Y.

How can you tell this from the graph?

---



---

10cii  
1 mark

*maximum 5 marks*

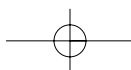

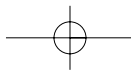

11. Molly used a pH sensor to test different liquids. She dipped the probe of the sensor into each liquid and recorded the pH value in a table.



- (a) In the table below, tick **one** box for each liquid to show whether it is **acidic**, **neutral** or **alkaline**. One has been done for you.

liquid	pH value	acidic	neutral	alkaline
alcohol	7			
dilute hydrochloric acid	2	✓		
distilled water	7			
vinegar	3			
sodium hydroxide solution	11			

11a  
1 mark

11a  
1 mark

- (b) Between each test Molly dipped the probe into distilled water.

- (i) Why did she do this?

11bi  
1 mark

\_\_\_\_\_

\_\_\_\_\_

- (ii) Which other liquid in the table could Molly use between tests to have the same effect as distilled water?

11bii  
1 mark

\_\_\_\_\_

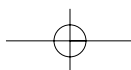

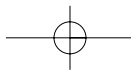

- (c) Molly put a piece of magnesium into a test-tube containing 20 cm<sup>3</sup> of vinegar. She put another piece of magnesium into a test-tube containing 20 cm<sup>3</sup> of dilute hydrochloric acid.

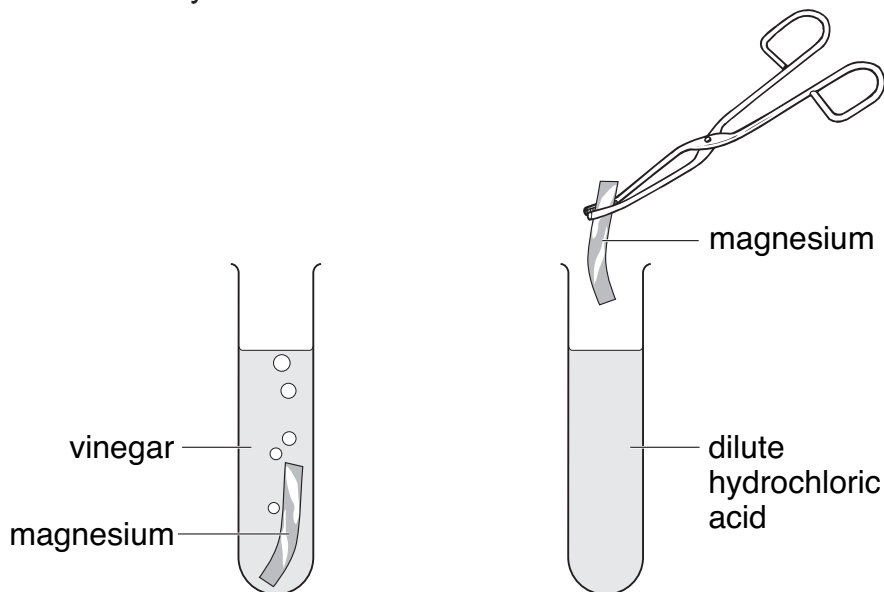

- (i) Molly thought that magnesium would react more vigorously with hydrochloric acid than with vinegar. What information in the table made Molly think this?

\_\_\_\_\_

\_\_\_\_\_

11ci  
1 mark

- (ii) How would Molly be able to tell if a more vigorous reaction took place with hydrochloric acid than with vinegar?

\_\_\_\_\_

\_\_\_\_\_

11cii  
1 mark

- (d) (i) Complete the word equation for the reaction between magnesium and hydrochloric acid.



11di  
1 mark

11di  
1 mark

- (ii) After some time this reaction stopped. Why did the reaction stop?

\_\_\_\_\_

\_\_\_\_\_

11dii  
1 mark

*maximum 9 marks*

Total  
  
9

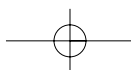

12. Two groups of pupils investigated the factors affecting the time taken for an indigestion tablet to dissolve in 100 cm<sup>3</sup> of water.

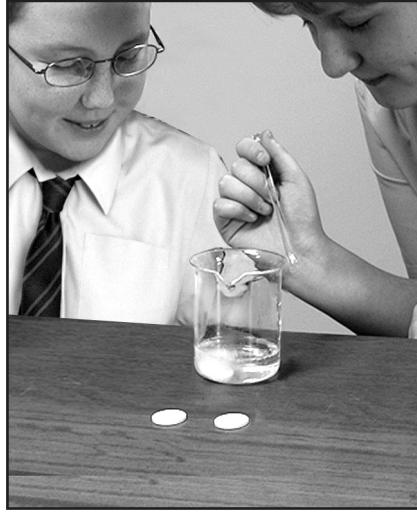

Group 1 recorded their results in the table below.

**results of group 1**

tablet	time taken to dissolve (s)
whole tablet	34
broken tablet	28
finely crushed tablet	22

- (a) What factor did group 1 change as they carried out their investigation?

12a  
1 mark

\_\_\_\_\_

- (b) Before the investigation, group 1 made a prediction. They found this prediction was supported by the results in the table.

What prediction did group 1 make?

12b  
1 mark

\_\_\_\_\_  
\_\_\_\_\_

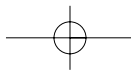

- (c) Group 2 investigated how the temperature of the water affects the time taken for a whole tablet to dissolve.

Here are their results.

**results of group 2**

temperature of water (°C)	time taken to dissolve (s)
65	24
40	35
15	90
5	100

What factor did group 2 change as they carried out their investigation?

---



---

12c  
1 mark

- (d) What pattern do the results recorded by group 2 show?

---



---

12d  
1 mark

- (e) Look at the results presented by group 1 and group 2.  
Both groups used the same type of tablet.

Estimate the temperature of water used by group 1.

\_\_\_\_\_ °C

12e  
1 mark

*maximum 5 marks*

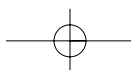

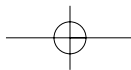

13. (a) When fertilisation takes place, the nucleus of a sperm joins with the nucleus of an ovum (egg).

In which part of the reproductive system does fertilisation normally take place in humans?

Tick the correct box.

cervix	<input type="checkbox"/>	ovary	<input type="checkbox"/>
oviduct	<input type="checkbox"/>	uterus	<input type="checkbox"/>

13a

1 mark

- (b) The table below gives information about fertilisation in three animals.

animal	Does fertilisation take place inside or outside the body?	number of eggs released at a time
human	inside	1
bird	inside	4
frog	outside	3000

Frogs release their eggs and sperm into water.

The eggs are fertilised in the water.

Why is it an advantage for frogs to release large numbers of eggs and sperm?

---



---



13b

1 mark

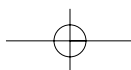

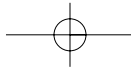

(c) The diagram shows a section through a fertilised egg of a bird.

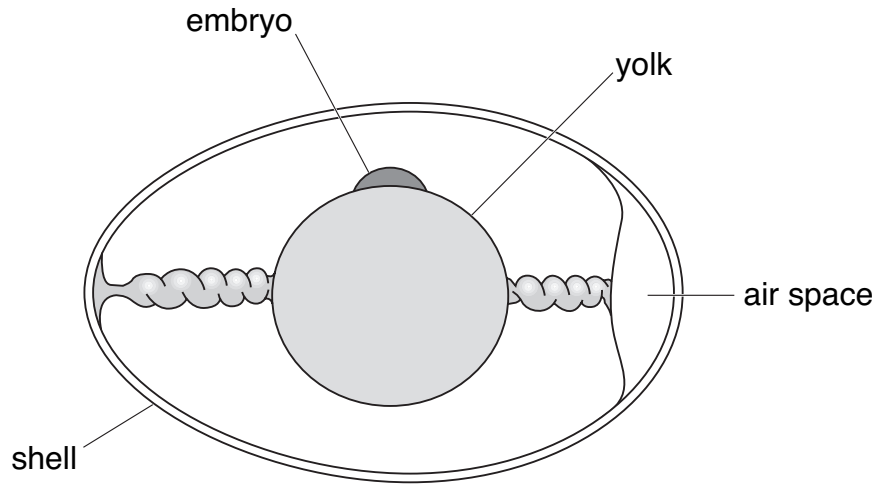

(i) The shell of a bird's egg is porous. This means it has microscopic holes in it.

Why does it need to be porous?

\_\_\_\_\_

(ii) Give **one** other function of the egg shell.

\_\_\_\_\_

(d) A bird's egg contains yolk which is a food store for the developing chick. A human egg does **not** contain yolk.

Why does a human egg **not** need to contain a food store for the embryo?

\_\_\_\_\_

\_\_\_\_\_

13ci  
1 mark

13cii  
1 mark

13d  
1 mark

*maximum 5 marks*

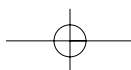

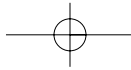

14. (a) The diagram shows a group of cells from the lining of the mouth.

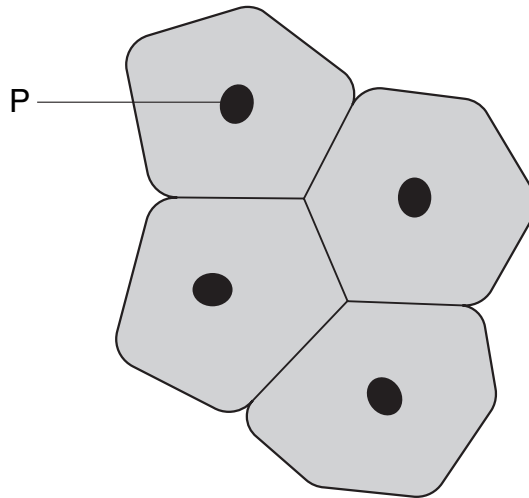

(i) Give the name and function of part P.

name of part P

\_\_\_\_\_

function of part P

\_\_\_\_\_

\_\_\_\_\_

(ii) Which word describes this group of cells?

Tick the correct box.

compound

organism

organ

tissue

14ai

1 mark

14ai

1 mark

14aii

1 mark

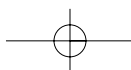

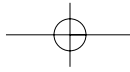

(b) The diagram below shows muscle cells from the wall of the human intestine.

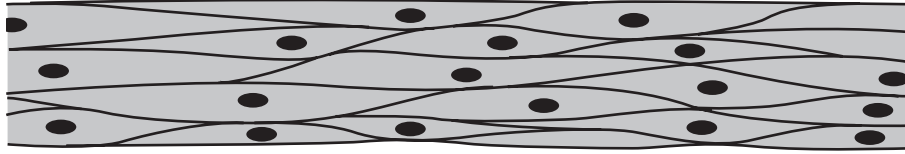

(i) Muscle cells can contract.

Give **one** reason why muscles are needed in the intestine.

\_\_\_\_\_  
\_\_\_\_\_

14bi  
1 mark

(ii) Other cells in the intestine produce enzymes.

What effect do enzymes in the intestine have on nutrients such as protein?

\_\_\_\_\_  
\_\_\_\_\_

14bii  
1 mark

(iii) Which of the following is required in the diet to keep food moving through the intestine?  
Tick the correct box.

fat	<input type="checkbox"/>	fibre	<input type="checkbox"/>
protein	<input type="checkbox"/>	starch	<input type="checkbox"/>

14biii  
1 mark

*maximum 6 marks*

Total  
  
6

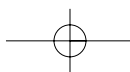

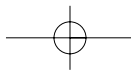

15. Suzi investigated how temperature affects the number of bubbles produced by waterweed in one minute.

She set up the experiment as shown below.

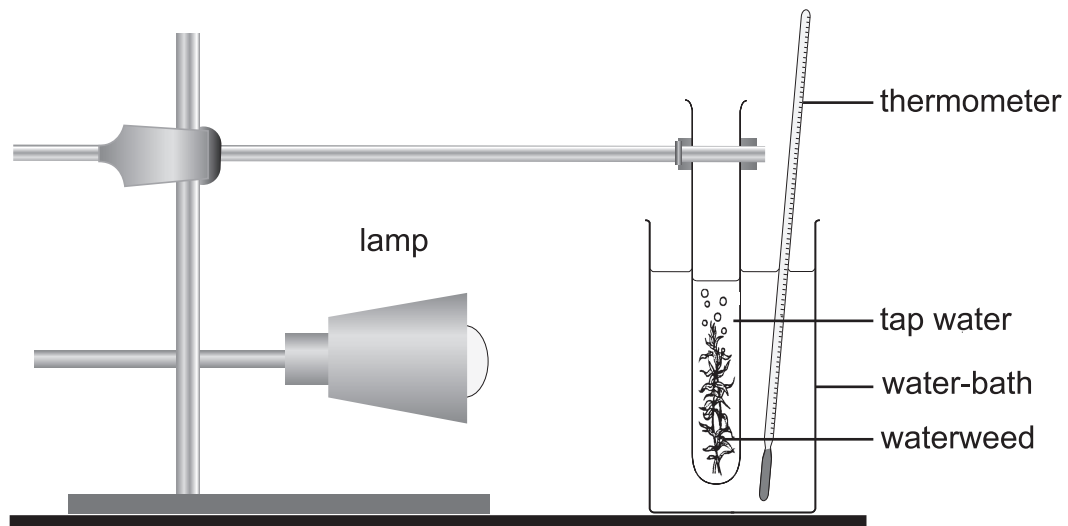

When the temperature of the water was  $10^{\circ}\text{C}$  the waterweed did **not** produce bubbles.

- (a) Suzi increased the temperature of the water in the water-bath to  $20^{\circ}\text{C}$ . The waterweed started to produce bubbles. She waited two minutes before starting to count the bubbles.

Explain why she waited for two minutes before she started to count the bubbles.

---

---

15a  
1 mark

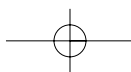

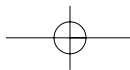

- (b) Suzi counted the number of bubbles produced at six different temperatures.

Her results are shown on the graph below.

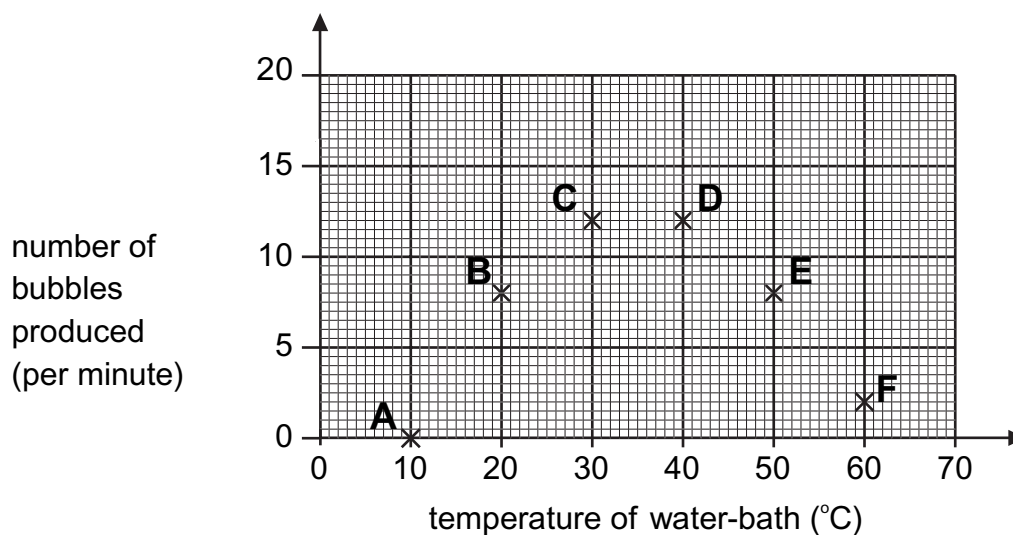

- (i) Draw a smooth curve on the graph.
- (ii) Use your curve to find the temperature of water which produced the most bubbles per minute.

\_\_\_\_\_ °C

- (c) Suzi predicted that the higher the temperature the more bubbles would be produced.

Which points on the graph support Suzi's prediction?

\_\_\_\_\_

- (d) Suzi's data does **not** show clearly the exact temperature at which most bubbles were produced.

How could she improve the data she collects to find this temperature?

\_\_\_\_\_

\_\_\_\_\_

*maximum 5 marks*

15bi  
1 mark

15bii  
1 mark

15c  
1 mark

15d  
1 mark

Total  
5

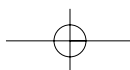

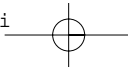

**END OF TEST**

